

# CITY CRANE MC 50 B

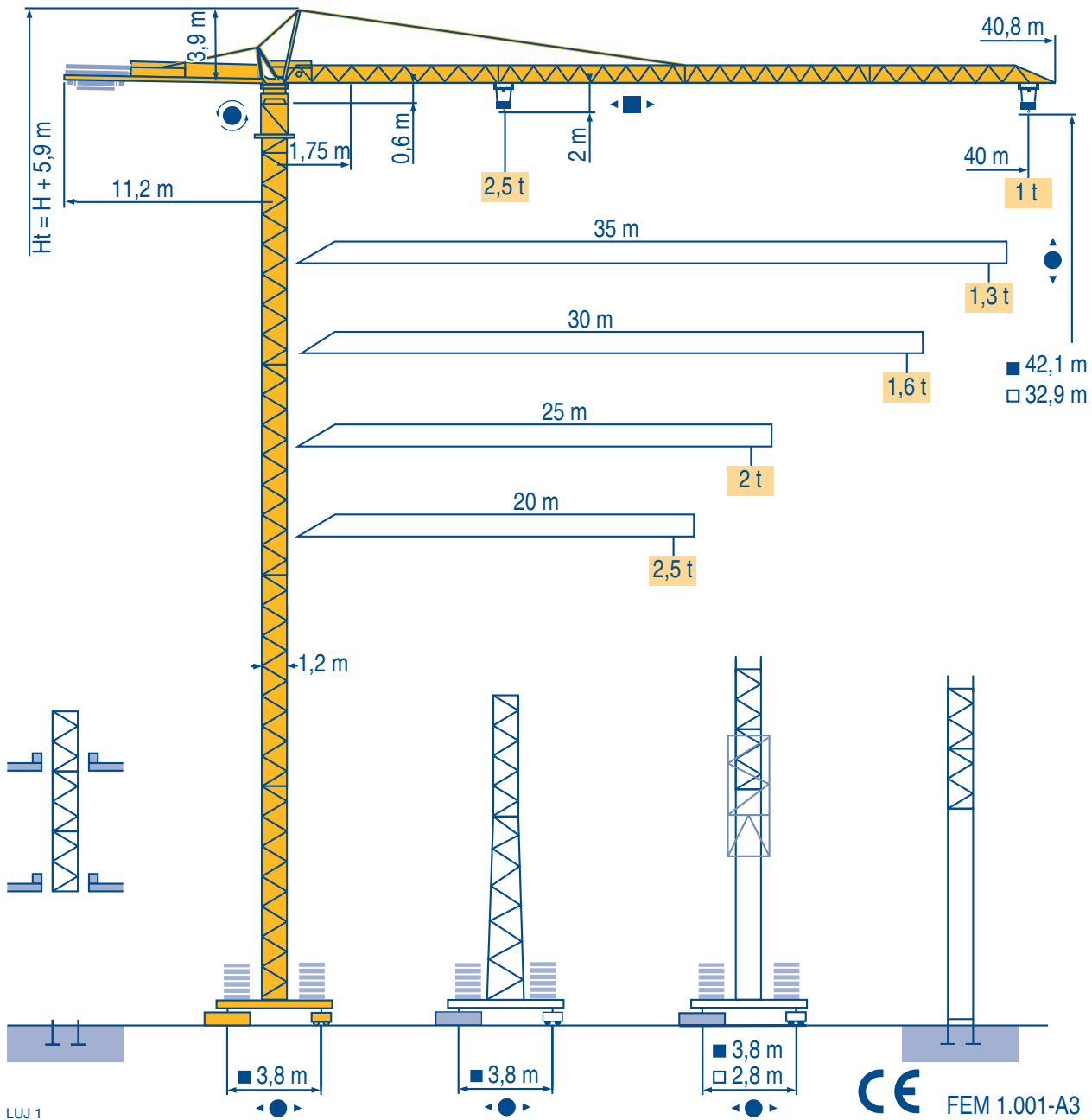

- Igo HD HDM
- HDT
- GTMR
- CITY CRANE
- TOPKIT MD MAXI MD
- MAXI TOPKIT
- Topless MDT
- MR





20 m → 40 m

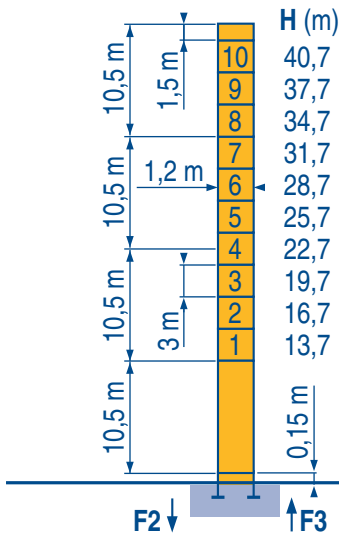

P 12 C

F2	● 60 t	■ 111 t
F3	● 47 t	■ 99 t
	▲	15,5 t

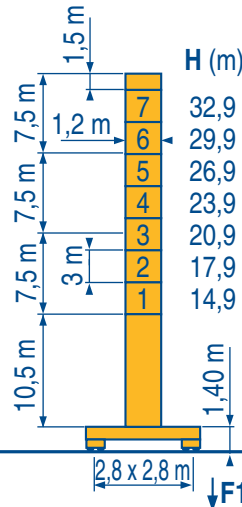

ZE 12 A

F1	● 40 t	■ 57 t
	▲	18 t

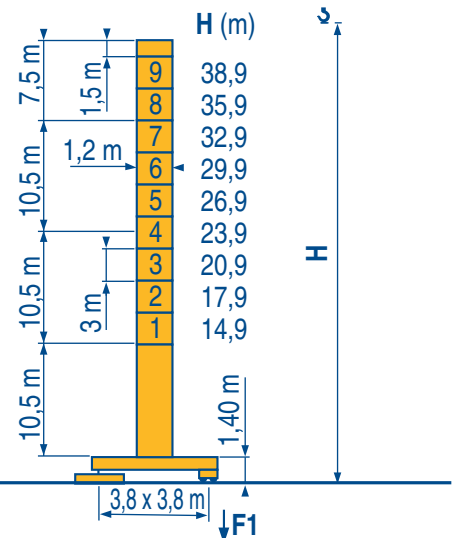

ZF 12 A / ZFC 12 A

F1	● 38 t	■ 54 t
	▲	20,5 t

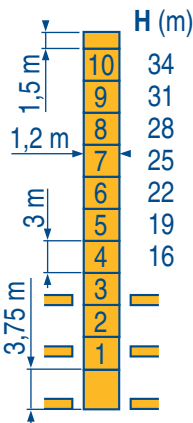

B 125 A / P 12 B

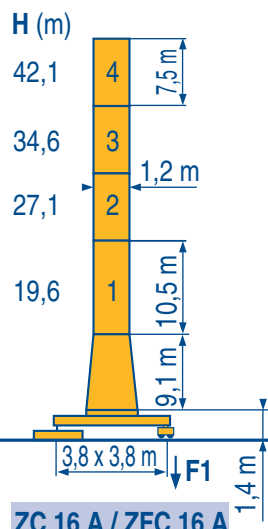

ZC 16 A / ZFC 16 A

F1	● 42 t	■ 64 t
	▲	23 t

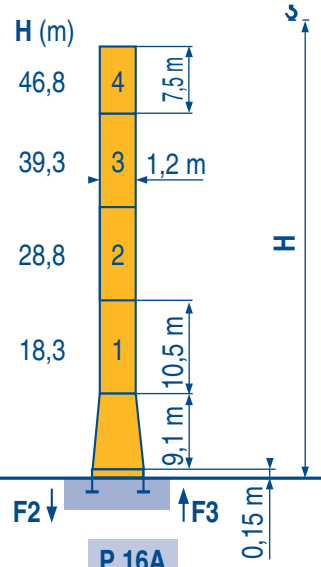

P 16 A

F2	● 52 t	■ 103 t
F3	● 39 t	■ 91 t
	▲	19 t

ZE - ZF - ZC - ZFC

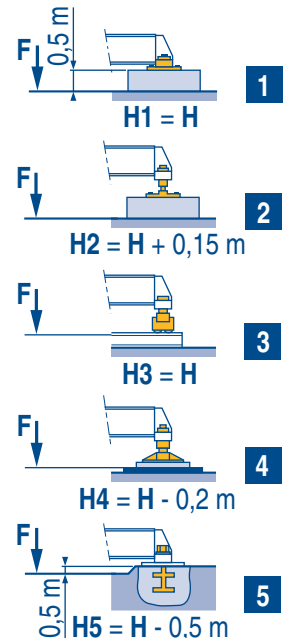

LUJ 2

● Réactions en service  
■ Réactions hors service  
▲ A vide sans lest (ni train de transport) avec flèche et hauteur maximum.

● Reaktionenkräfte in Betrieb  
■ Reaktionenkräfte außer Betrieb  
▲ Ohne Last, Ballast (und Transportachse), mit Maximalausleger und Maximalhöhe.

● Reactions in service  
■ Reactions out of service  
▲ Without load, ballast (or transport axles), with maximum jib and maximum height.

● Reacciones en servicio  
■ Reacciones fuera de servicio  
▲ Sin carga, sin lastre, (ni tren de transporte), flecha y altura máxima.

● Reazioni in servizio  
■ Reazioni fuori servizio  
▲ A vuoto, senza zavorra (ne assali di trasporto) con braccio massimo e altezza massima.

● Reações em serviço  
■ Reações fora de serviço  
▲ Sem carga (nem trem de transporte)-sem lastro com lança e altura máximas.

40 m	1,75 ▶	18,6	20	22	25	27	30	32	35	37	40 m
▲▲▲	☪	2,5	2,3	2,1	1,78	1,62	1,43	1,32	1,18	1,1	1 t
35 m	1,75 ▶	20,1	22	25	27	30	32	35 m			
▲▲▲	☪	2,5	2,25	1,95	1,78	1,57	1,45	1,3			
30 m	1,75 ▶	20,5	22	25	27	30 m					
▲▲▲	☪	2,5	2,3	1,98	1,81	1,6					
25 m	1,75 ▶	20,6	22	25 m							
▲▲▲	☪	2,5	2,3	2							
20 m	1,75 ▶	20 m									
▲▲▲	☪	2,5									

LWJ 1

B 125 A

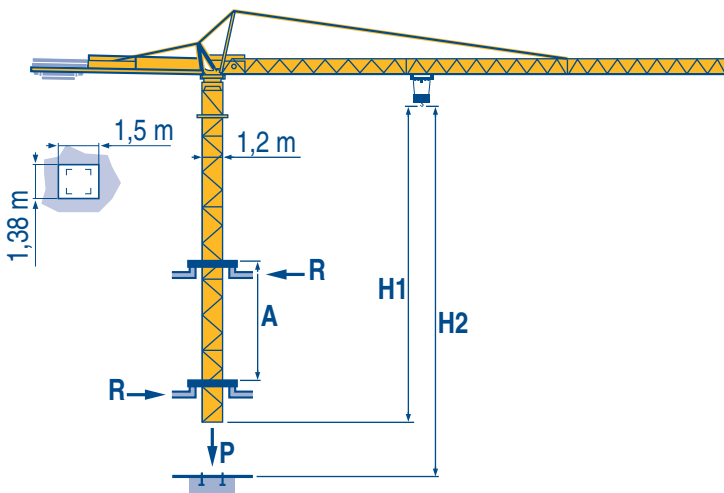

LWJ 1

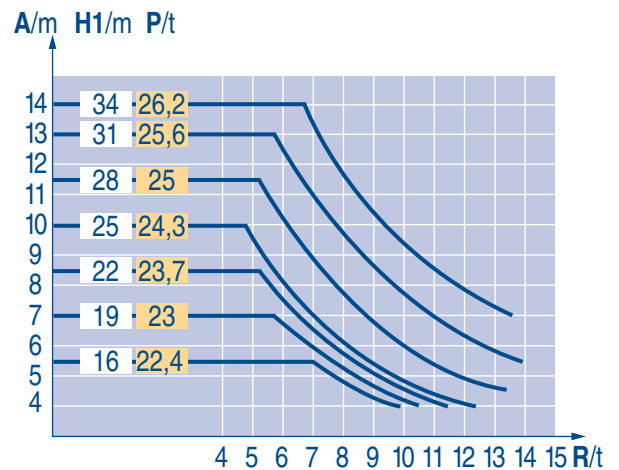

<b>A</b>	Distance entre cadres	F	Abstand zwischen den Rahmen	D	Distance between collars	GB	Distancia entre marcos	E	Distanza fra i telai	I	Distância entre quadros	P
<b>H1</b>	Hauteur grue		Kranhöhe		Crane height		Altura grúa		Altezza gru		Altura da grua	
<b>P</b>	Poids de la grue (en service)		Krangewicht (in Betrieb)		Crane weight (in service)		Peso de la grúa (en servicio)		Peso della gru (in servizio)		Peso da grua (em serviço)	
<b>R</b>	Réaction horizontale		Horizontalkräfte		Horizontal reaction		Reaccion horizontal		Reazione orizzontale		Reacção horizontal	

					ch - PS hp	kW		
	15 PC 13-5	m/min	7,1	21	42	15	11	130 m
		t	2,5	2,5	1,3			
	25 PC 13-7	m/min	7,9	31,5	63	25	18	229 m
		t	2,5	2,5	1,3			
	3 D2 V5	m/min	21 - 42			3	2,2	
	RCV 40	tr/min U/min rpm	0 → 0,8			6	4,5	
	TVD 324	m/min	26			2 x 4	2 x 2,9	
	RT 224	m/min	25			2 x 4	2 x 2,9	

CEI 38	IEC 38	kVA	
400 V (+6% -10%) 50 Hz		15 PC : 25 kVA 25 PC : 35 kVA	84/534 - 87/405

LUJ 3

	F	D	GB	E	I	P
Levage	Heben	Hoisting	Elevación	Sollevamento	Elevação	
Distribution	Katzfahren	Trolleying	Distribución	Distribuzione	Distribuição	
Orientation	Schwenken	Slewing	Orientación	Rotazione	Rotação	
Translation	Kranfahren	Travelling	Traslación	Traslazione	Translação	
	Conforme aux directives CEE 84/534 et 87/405 sur le niveau acoustique		Conforme con las directivas CEE 84/534 y 87/405 sobre el nivel acustico		Conforme alle direttive CEE 84/534 e 87/405 sul livello acustico	
	Gemäss EWG-Richtlinien 84/534 und 87/405 für den Schall-Leistungspegel		In compliance with the EEC 84/534 and 87/405 Instructions on noise level		Conforme as directivas CEE 84/534 e 87/405 sobre o nível acústico	



Document commercial non contractuel. Pour toute information technique se référer à la notice correspondante

Unverbindliches Vertriebsdokument. Für technische Informationen, siehe die entsprechenden Anweisungen.

This commercial document is not legally binding. For any technical information, please refer to the corresponding instructions.

Documento comercial no contractual. Para cualquier información técnica, ver la noticia correspondiente.

Documento commerciale non vincolante, per tutte le informazioni tecniche fare riferimento al catalogo istruzioni

Documento comercial não contratual. Para qualquer informação técnica complementar consultar as respectivas instruções

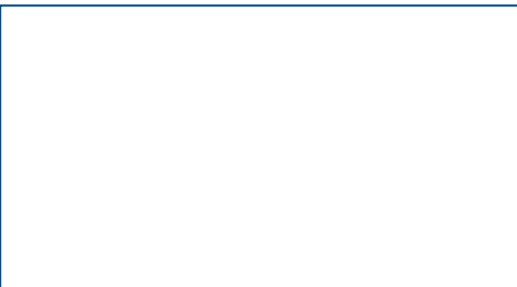

**POTAIN**

18.Rue de Charbonnières, B.P. 173  
F-69132 ECULLY Cedex  
Tél. (33)04.72.18.20.20  
Fax (33)04.72.18.20.00  
http://www.potain.com  
E-mail : mkt@potain.fr

Manitowoc Crane Group

**Deutschland**  
POTAIN GmbH Tel : 06.1.05.70.40  
**Italia**  
POTAIN S.p.A. Tel : 0.331.49.33.11  
**Portugal**  
POTAIN Portugal Tel : 22.968.08.89  
**Singapore**  
MANITOWOC POTAIN PTE LTD Tel : 227.15.50

Copyright.Reproduction interdite © POTAIN 2000

**CITY CRANE MC 50 B**  
Réf. 2000.36 LUJ 6